



STPS41H100CG/CT

LOW DROP POWER SCHOTTKY RECTIFIER

MAIN PRODUCTS CHARACTERISTICS

$I_{F(AV)}$	2 x 20 A
V_{RRM}	100 V
$T_j(\text{max})$	175 °C
$V_F(\text{max})$	0.67 V

FEATURES AND BENEFITS

- Negligible switching losses
- Low leakage current
- Good trade off between leakage current and forward voltage drop
- Low thermal resistance

DESCRIPTION

Dual center tab Schottky rectifier suited for Switch Mode Power Supply and high frequency DC to DC converters.

Packaged in D²PAK and TO-220AB, this device is intended for use in high frequency inverters.

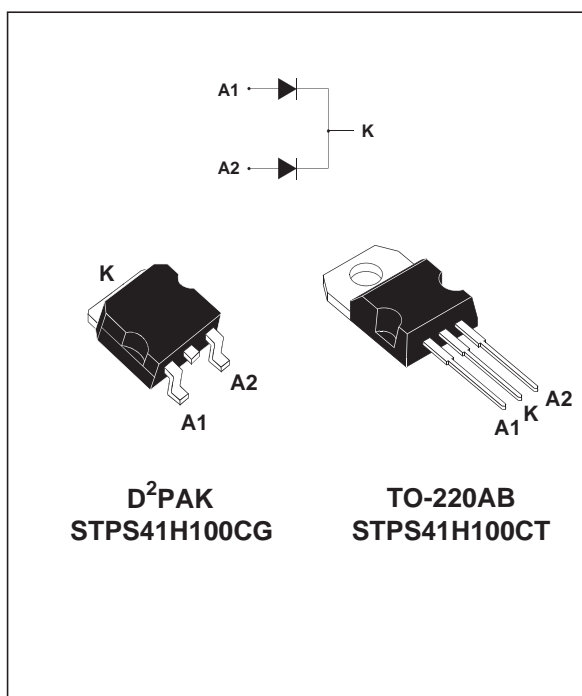

ABSOLUTE RATINGS (limiting values, per diode)

Symbol	Parameter		Value	Unit	
V_{RRM}	Repetitive peak reverse voltage		100	V	
$I_{F(RMS)}$	RMS forward current		30	A	
$I_{F(AV)}$	Average forward current	$T_c = 150^\circ\text{C}$	Per diode	20	A
		$\delta = 0.5$	Per device	40	
I_{FSM}	Surge non repetitive forward current	$t_p = 10 \text{ ms}$ sinusoidal	220	A	
I_{RRM}	Peak repetitive reverse current	$t_p = 2 \mu\text{s}$ square $F = 1\text{kHz}$	1	A	
T_{stg}	Storage temperature range		- 65 to + 175	°C	
T_j	Maximum operating junction temperature *		175	°C	
dV/dt	Critical rate of rise reverse voltage		10000	V/ μs	

* : $\frac{dP_{tot}}{dT_j} < \frac{1}{R_{th(j-a)}}$ thermal runaway condition for a diode on its own heatsink

STPS41H100CG/CT

THERMAL RESISTANCES

Symbol	Parameter		Value	Unit
$R_{th(j-c)}$	Junction to case	Per diode	1.5	$^{\circ}\text{C/W}$
		Total	0.8	
$R_{th(c)}$	Coupling		0.1	

When the diodes 1 and 2 are used simultaneously :

$$\Delta T_j(\text{diode 1}) = P(\text{diode 1}) \times R_{th(j-c)}(\text{Per diode}) + P(\text{diode 2}) \times R_{th(c)}$$

STATIC ELECTRICAL CHARACTERISTICS (per diode)

Symbol	Parameter	Tests Conditions		Min.	Typ.	Max.	Unit
I_R^*	Reverse leakage current	$T_j = 25^{\circ}\text{C}$	$V_R = V_{RRM}$			10	μA
		$T_j = 125^{\circ}\text{C}$			3	10	mA
V_F^*	Forward voltage drop	$T_j = 25^{\circ}\text{C}$	$I_F = 20\text{ A}$			0.80	V
		$T_j = 125^{\circ}\text{C}$	$I_F = 20\text{ A}$		0.62	0.67	
		$T_j = 25^{\circ}\text{C}$	$I_F = 40\text{ A}$			0.90	
		$T_j = 125^{\circ}\text{C}$	$I_F = 40\text{ A}$		0.70	0.76	

Pulse test : * $t_p = 380\ \mu\text{s}$, $\delta < 2\%$

To evaluate the conduction losses use the following equation :

$$P = 0.58 \times I_{F(AV)} + 0.0045 I_{F(RMS)}^2$$

Fig. 1: Conduction losses versus average current.

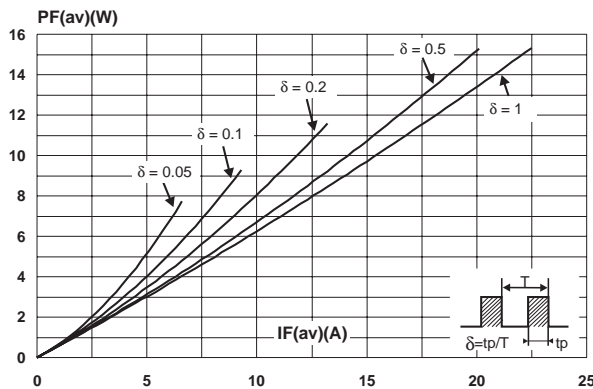

Fig. 2: Average forward current versus ambient temperature ($\delta = 0.5$).

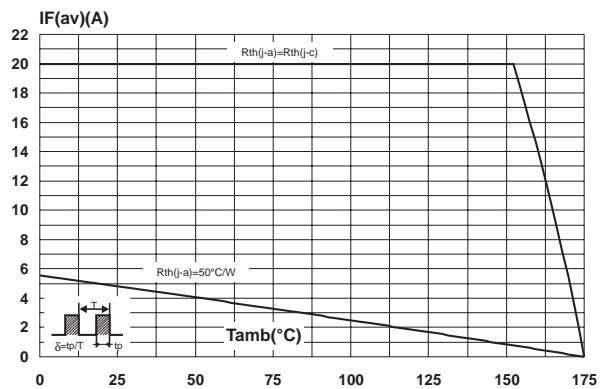

Fig. 3: Non repetitive surge peak forward current versus overload duration (maximum values).

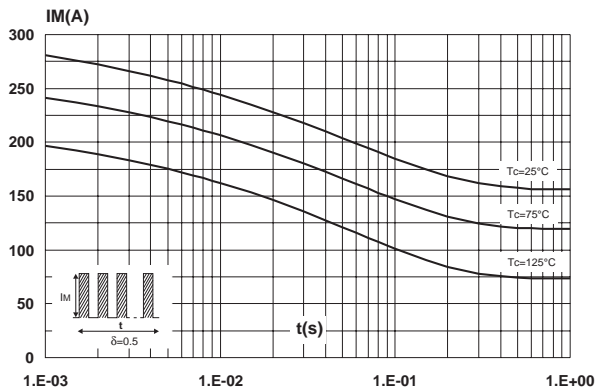

Fig. 4: Relative variation of thermal impedance junction to case versus pulse duration.

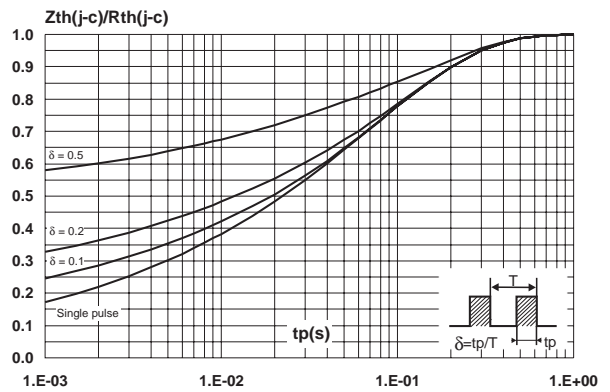

Fig. 5: Reverse leakage current versus reverse voltage applied (typical values).

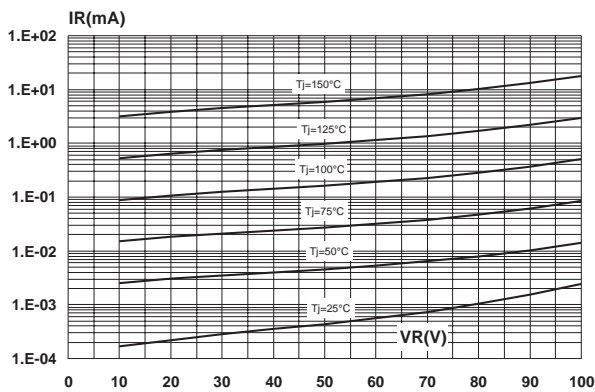

Fig. 6: Junction capacitance versus reverse voltage applied (typical values).

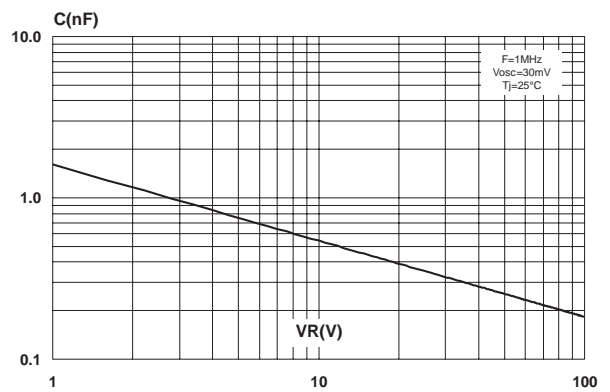

Fig. 7: Forward voltage drop versus forward current.

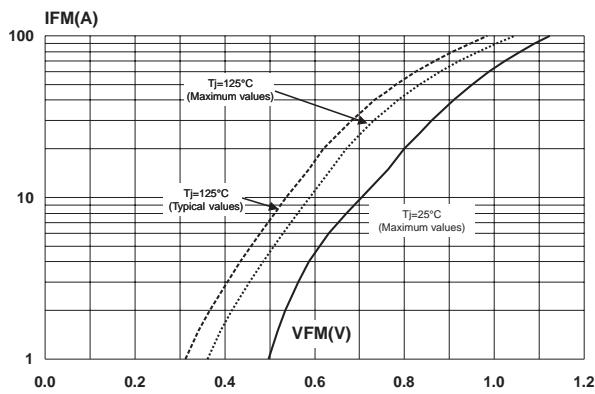
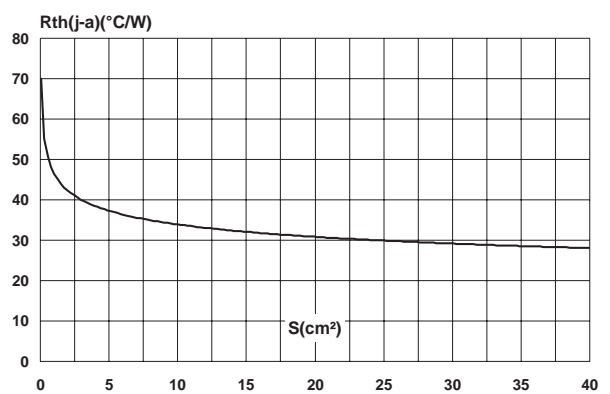
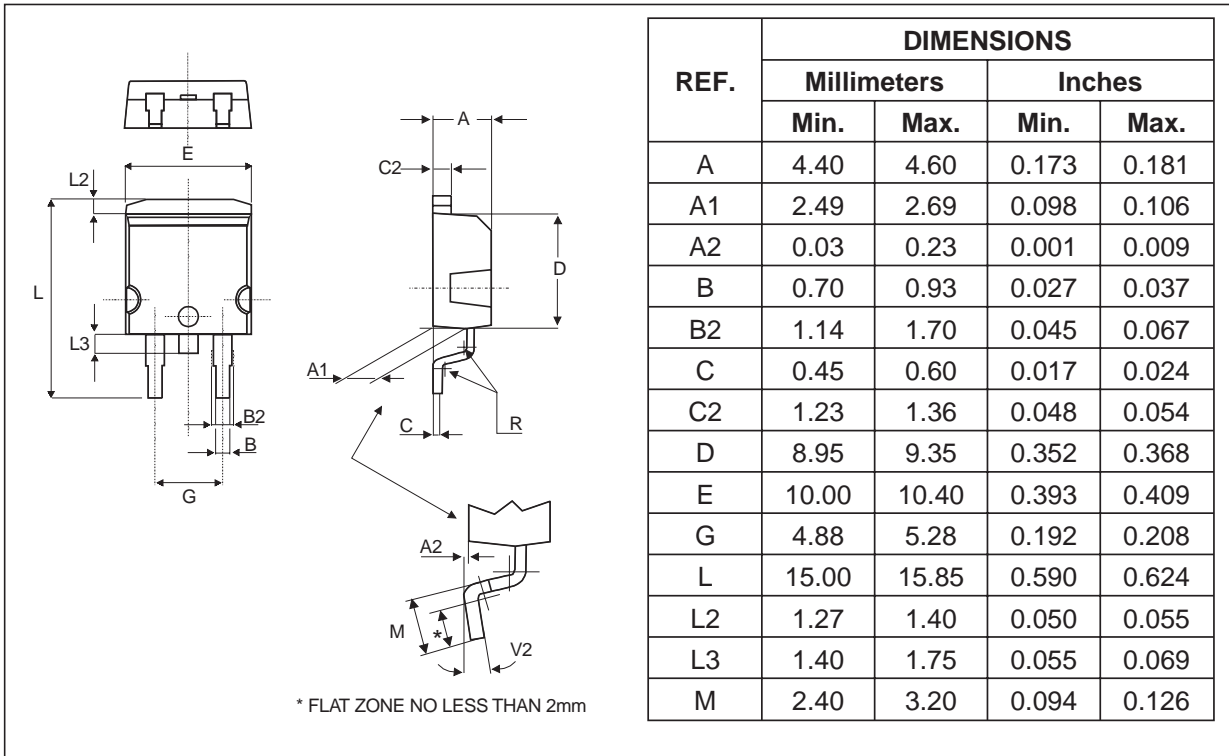

Fig. 8: Thermal resistance junction to ambient versus copper surface under tab (epoxy printed board FR4, $\text{Cu} = 35\mu\text{m}$). (STPS41H100CG only)



STPS41H100CG/CT

PACKAGE MECHANICAL DATA
D²PAK



FOOTPRINT (dimensions in mm)

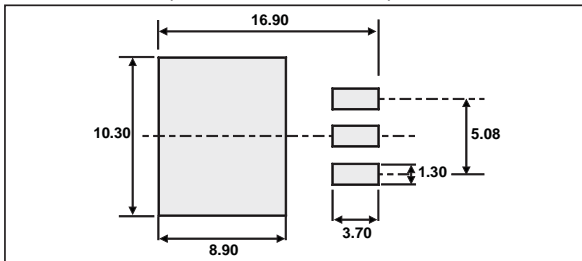

PACKAGE MECHANICAL DATA
TO-220AB

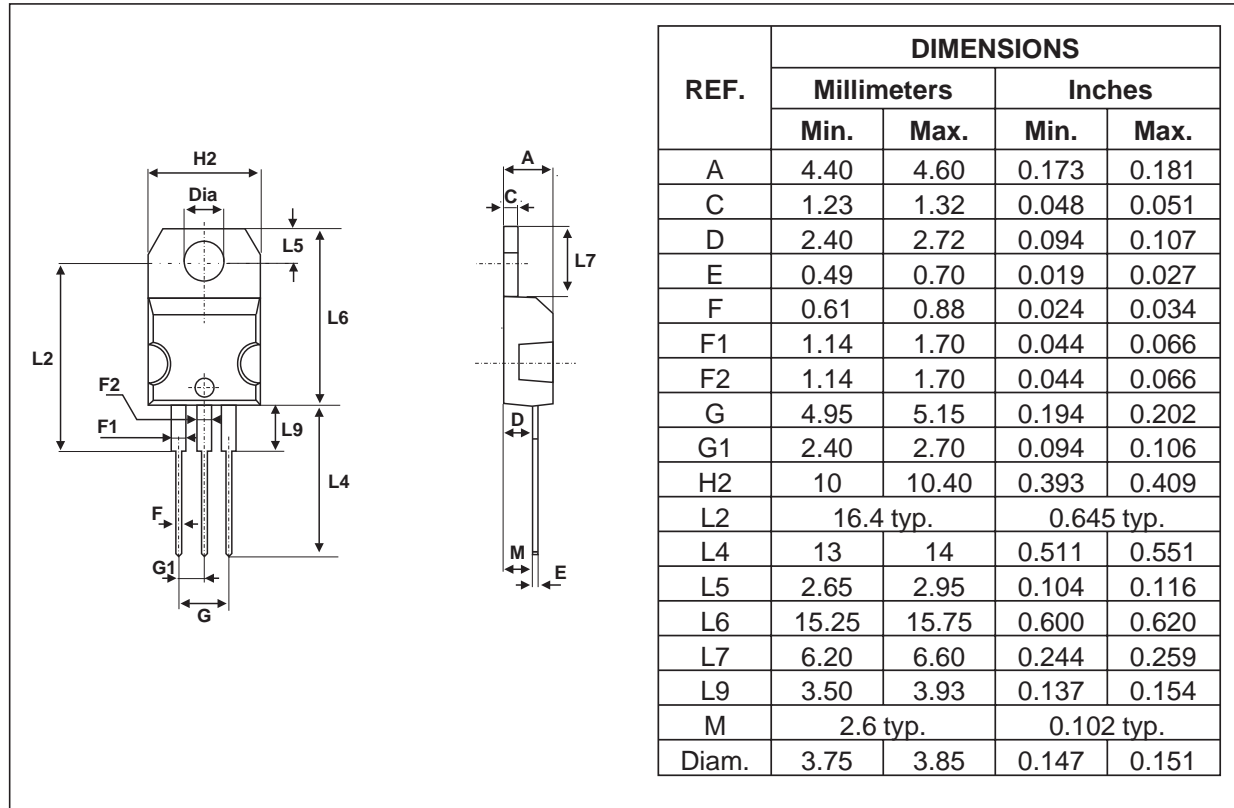

Ordering type	Marking	Package	Weight	Base qty	Delivery mode
STPS41H100CT	STPS41H100CT	TO-220AB	2.20 g	50	Tube
STPS41H100CG	STPS41H100CG	D ² PAK	1.48 g	50	Tube
STPS41H100CG-TR	STPS41H100CG	D ² PAK	1.48 g	1000	Tape & reel

- Epoxy meets UL94,V0

Information furnished is believed to be accurate and reliable. However, STMicroelectronics assumes no responsibility for the consequences of use of such information nor for any infringement of patents or other rights of third parties which may result from its use. No license is granted by implication or otherwise under any patent or patent rights of STMicroelectronics. Specifications mentioned in this publication are subject to change without notice. This publication supersedes and replaces all information previously supplied. STMicroelectronics products are not authorized for use as critical components in life support devices or systems without express written approval of STMicroelectronics.

The ST logo is a registered trademark of STMicroelectronics
 © 2002 STMicroelectronics - Printed in Italy - All rights reserved.
 STMicroelectronics GROUP OF COMPANIES
 Australia - Brazil - Canada - China - Finland - France - Germany
 Hong Kong - India - Israel - Italy - Japan - Malaysia - Malta - Morocco - Singapore
 Spain - Sweden - Switzerland - United Kingdom - United States.



<http://www.st.com>

This datasheet has been download from:

www.datasheetcatalog.com

Datasheets for electronics components.